

## COUNTERTOP WITH FRAME

STAINLESS STEEL FLAT COUNTERTOP  
WITH STAINLESS STEEL FRAME

## COUNTERTOP WITH FRAME

- 84"L X 36"W X 1"T
- S/S - 2" X 2" SQ TUBING LEGS
- S/S - 1.5" X 1.5" SQ TUBING STRECHERS
- S/S - 4" WELD ON RAILS ON ALL FOUR SIDES
- 4 - ADJUSTABLE BULLET FEET
- ALSO AVAILABLE IN 24" & 30" DEPTHS
- **\*OPTIONAL\*** - S/S - FIXED/REMOVABLE LOWER SHELF
- **\*OPTIONAL\*** - 4" LOCKING CASTERS INSTEAD OF BULLET FEET

## PRODUCT DIMENSIONS

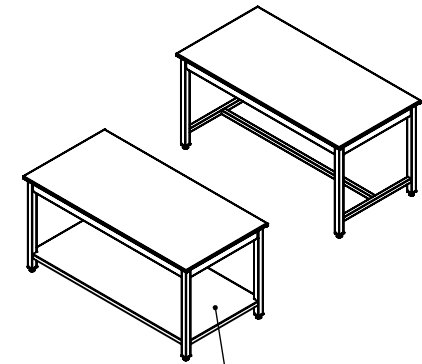
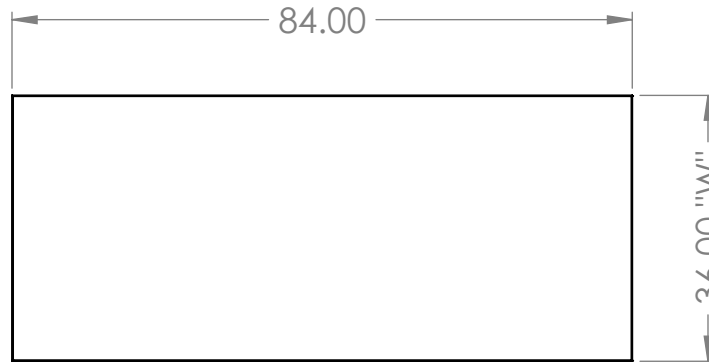

**\*OPTIONAL\***  
LOWER SHELF

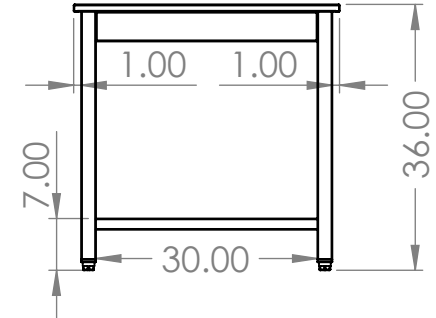
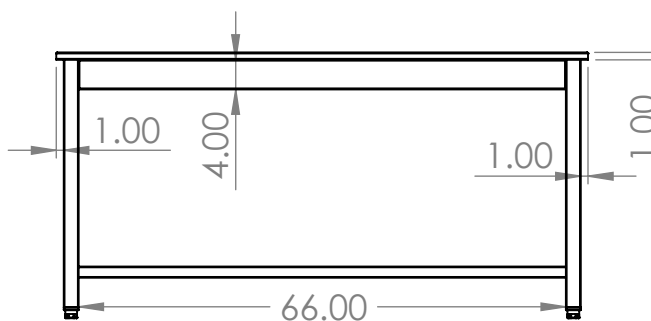
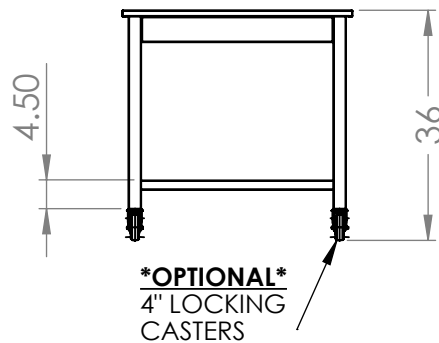

### UNLESS OTHERWISE SPECIFIED:

DIMENSIONS ARE IN INCHES  
TOLERANCES:  
ANGULAR ±2.50°  
ONE-PLACE ±0.5  
TWO-PLACE ±0.13

### PROPRIETARY AND CONFIDENTIAL

THE INFORMATION CONTAINED IN THIS DRAWING IS THE SOLE PROPERTY OF INTER DYNE SYSTEMS. ANY REPRODUCTION IN PART OR AS A WHOLE WITHOUT THE WRITTEN PERMISSION OF INTER DYNE SYSTEMS IS PROHIBITED.

REV.	REVISION DESCRIPTION	DRAWN	CHECKED	DATE	COMMENTS:
A	SUBMITTALS SENT	ASR		--/--/--	HAT CHANNEL AND SOUND DEADENER TO BE APPLIED IN FINAL ASSEMBLY
					<b>QTY: N/A</b>



**INTER DYNE  
SYSTEMS, INC**

676 E. Ellis Rd., Norton Shores, MI 49441  
Phone: 231-799-8760 Fax: 231-799-9690

**PART NO.**

**84 X 36 X 1 - CTOP - FRAME**

MATERIAL: **16GA**

FINISH: **304 #4**