

## COUNTERTOP WITH FRAME

STAINLESS STEEL FLAT COUNTERTOP  
WITH ADJUSTABLE STAINLESS STEEL  
FRAME

## COUNTERTOP WITH FRAME

- 48"L X 30"W X 1"T
- S/S - 2" X 2" SQ TUBING  
ADJUSTABLE LEGS
- S/S - 1.5" X 1.5" SQ TUBING  
STRECHERS
- S/S - 4" WELD ON RAILS ON ALL  
FOUR SIDES
- 4 - ADJUSTABLE LEVELER FEET
- ALSO AVAILABLE IN 24" & 36"  
DEPTHS
- **\*OPTIONAL\*** - S/S -  
FIXED/REMOVABLE LOWER SHELF
- **\*OPTIONAL\*** - 4" LOCKING  
CASTERS INSTEAD OF LEVELER  
FEET

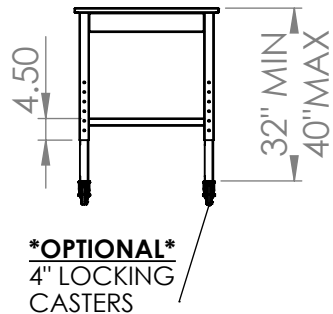

## PRODUCT DIMENSIONS

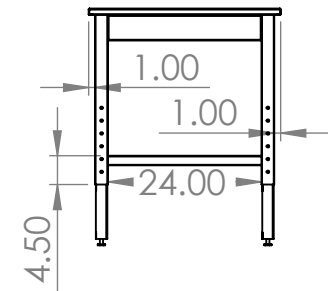
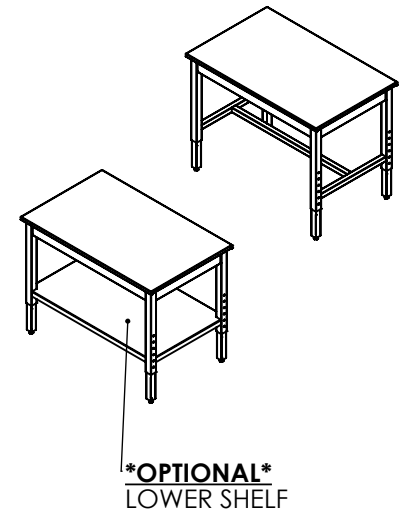
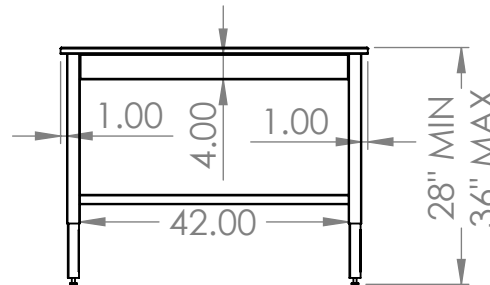
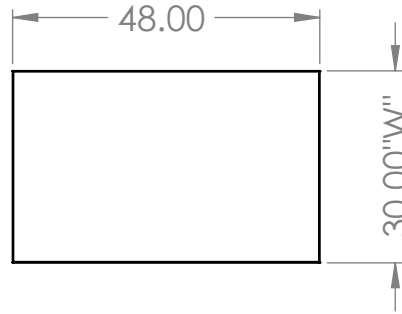

### UNLESS OTHERWISE SPECIFIED:

DIMENSIONS ARE IN INCHES  
TOLERANCES:  
ANGULAR ±2.50°  
ONE-PLACE ±0.5  
TWO-PLACE ±0.13

### PROPRIETARY AND CONFIDENTIAL

THE INFORMATION CONTAINED IN  
THIS DRAWING IS THE SOLE  
PROPERTY OF INTER DYNE SYSTEMS.  
ANY REPRODUCTION IN PART OR  
AS A WHOLE WITHOUT THE WRITTEN  
PERMISSION OF INTER DYNE  
SYSTEMS IS PROHIBITED.

REV.	REVISION DESCRIPTION	DRAWN	CHECKED	DATE	COMMENTS:
A	SUBMITTALS SENT	ASR		--/--/--	HAT CHANNEL AND SOUND DEADENER TO BE APPLIED IN FINAL ASSEMBLY
					<b>QTY: N/A</b>



**INTER DYNE  
SYSTEMS, INC**

676 E. Ellis Rd., Norton Shores, MI 49441  
Phone: 231-799-8760 Fax: 231-799-9690

### PART NO.

48 X 30 X 1 - CTOP - ADJ - FRAME

MATERIAL: **16GA**

FINISH: **304 #4**