

# "SCUL-1B" 1 BOWL SCULLERY

Stainless steel simple scullery  
with 1 integral sink bowl and NO shelf

## Features

- 14GA Construction
- 2" x 2" Square Tubing Legs
- 1.5" x 1.5" Square Tubing Stretchers
- Adjustable Height Bullet Feet
- \*Please see -DLX or -RFD drawings for additional options

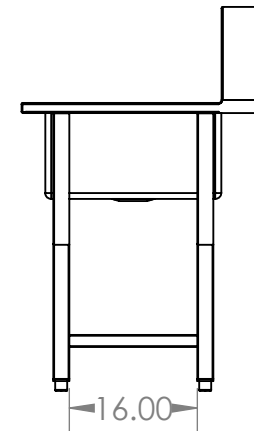
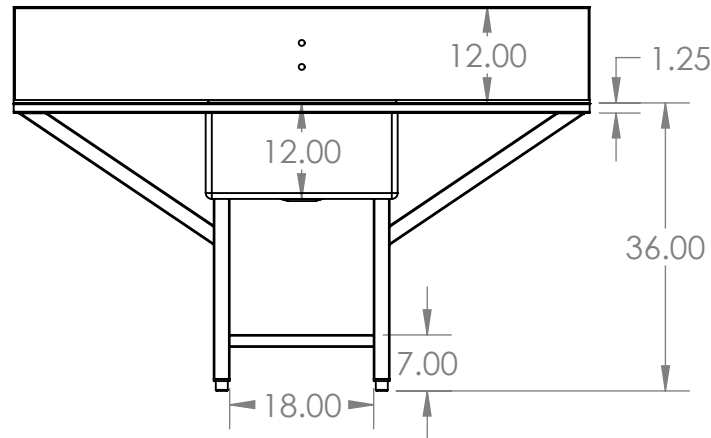
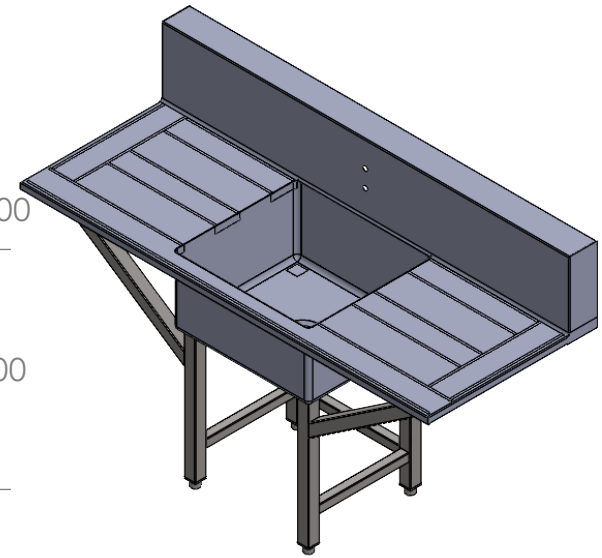
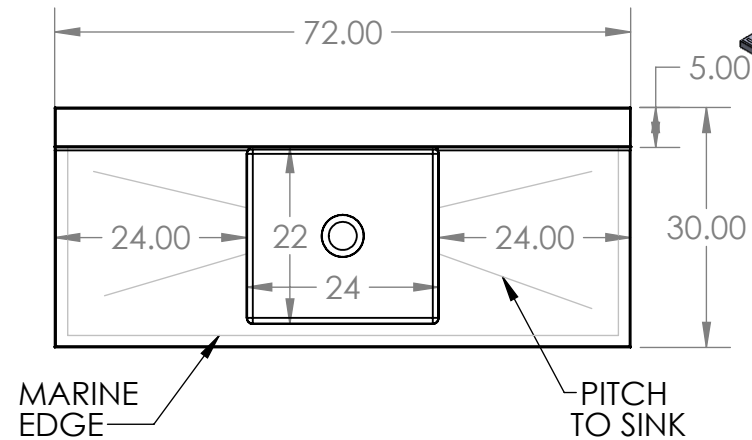

### UNLESS OTHERWISE SPECIFIED:

DIMENSIONS ARE IN INCHES  
TOLERANCES:  
ANGULAR ±2.50°  
ONE-PLACE ±0.5  
TWO-PLACE ±0.13

### PROPRIETARY AND CONFIDENTIAL

THE INFORMATION CONTAINED IN THIS DRAWING IS THE SOLE PROPERTY OF INTER DYNE SYSTEMS. ANY REPRODUCTION IN PART OR AS A WHOLE WITHOUT THE WRITTEN PERMISSION OF INTER DYNE SYSTEMS IS PROHIBITED.

REV.	REVISION DESCRIPTION	DRAWN	CHECKED	DATE	COMMENTS:
A	SUBMITTALS SENT	ASR		05/20/22	HAT CHANNEL AND SOUND DEADENER TO BE APPLIED IN FINAL ASSEMBLY
					<b>QTY:</b>



**INTER DYNE SYSTEMS, INC**  
676 E. Ellis Rd., Norton Shores, MI 49441  
Phone: 231-799-8760 Fax: 231-799-9690

**PART NO.**

**SCUL-72-1B**

MATERIAL: **14GA**

FINISH: **304 #4**