

CABINET COMES WITH ONE ADJUSTABLE SHELF

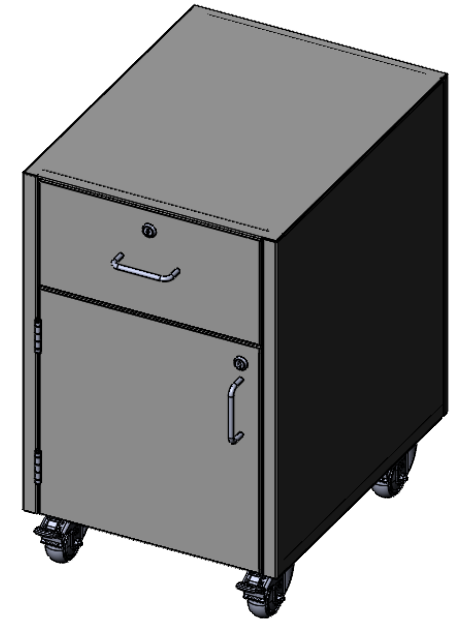
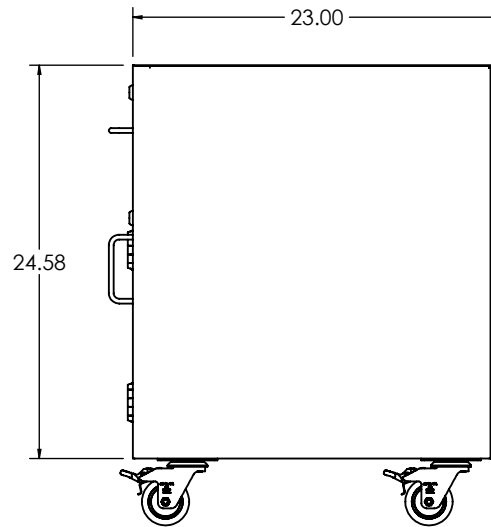
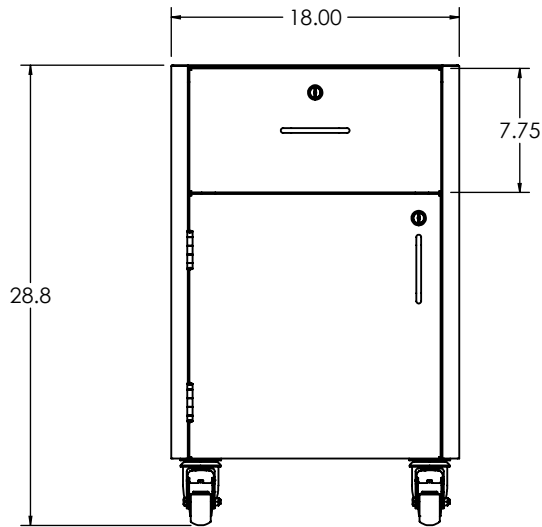

**UNLESS OTHERWISE SPECIFIED:**

DIMENSIONS ARE IN INCHES  
TOLERANCES:  
ANGULAR ±1.0°  
ONE-PLACE ±0.060  
TWO-PLACE ±0.030  
THREE-PLACE ±0.015

**PROPRIETARY AND CONFIDENTIAL**

THE INFORMATION CONTAINED IN THIS DRAWING IS THE SOLE PROPERTY OF INTER DYNE SYSTEMS. ANY REPRODUCTION IN PART OR AS A WHOLE WITHOUT THE WRITTEN PERMISSION OF INTER DYNE SYSTEMS IS PROHIBITED.

REV.	REVISION DESCRIPTION	DRAWN	CHECKED	DATE	COMMENTS:
A	NEW	SJA		10/05/23	

**QTY:**



**INTER DYNE SYSTEMS, INC**

676 E. Ellis Rd., Norton Shores, MI 49441  
Phone: 231-799-8760 Fax: 231-799-9690

**PART NO. SMC2918-A-LH-LK**

**DESCRIPTION** MOBILE CAB. "A" 29 X 18

MATERIAL: 304 SS

FINISH: #4