

COUNTERTOP WITH FRAME

STAINLESS STEEL FLAT COUNTERTOP
WITH STAINLESS STEEL FRAME

COUNTERTOP WITH FRAME

- 84"L X 30"W X 1" T
- S/S - 2" X 2" SQ TUBING LEGS
- S/S - 1.5" X 1.5" SQ TUBING STRECHERS
- S/S - 4" WELD ON RAILS ON ALL FOUR SIDES
- 4 - ADJUSTABLE BULLET FEET
- ALSO AVAILABLE IN 24 & 36" DEPTHS
- ***OPTIONAL*** - S/S - FIXED/REMOVABLE LOWER SHELF
- ***OPTIONAL*** - 4" LOCKING CASTERS INSTEAD OF BULLET FEET

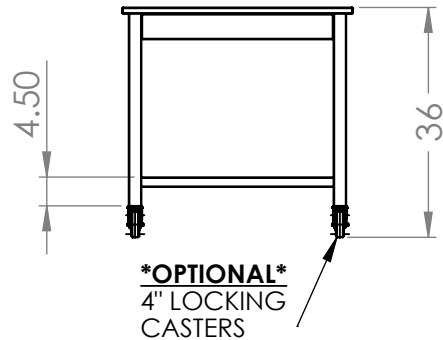

PRODUCT DIMENSIONS

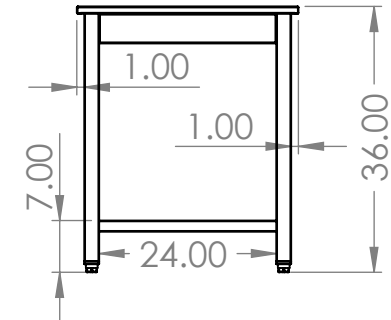
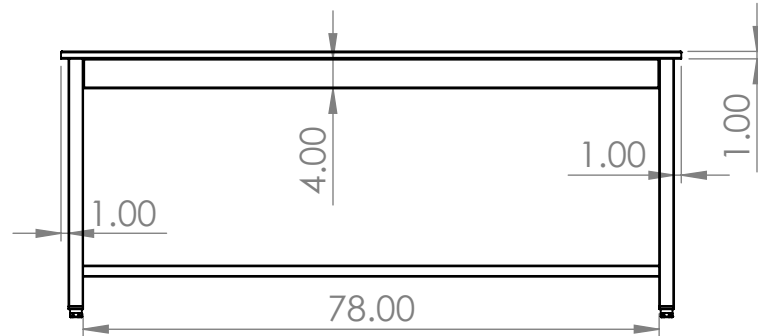
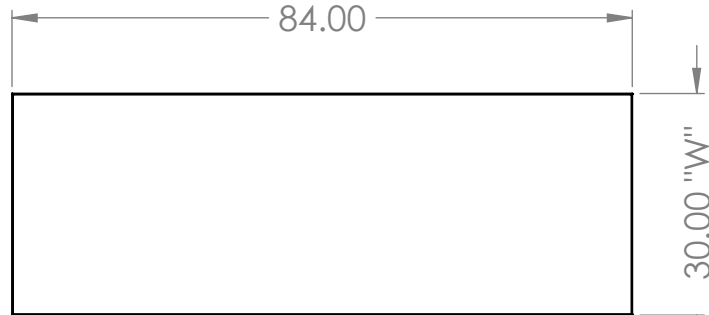

UNLESS OTHERWISE SPECIFIED:

DIMENSIONS ARE IN INCHES
TOLERANCES:
ANGULAR ±2.50°
ONE-PLACE ±0.5
TWO-PLACE ±0.13

PROPRIETARY AND CONFIDENTIAL

THE INFORMATION CONTAINED IN THIS DRAWING IS THE SOLE PROPERTY OF INTER DYNE SYSTEMS. ANY REPRODUCTION IN PART OR AS A WHOLE WITHOUT THE WRITTEN PERMISSION OF INTER DYNE SYSTEMS IS PROHIBITED.

REV.	REVISION DESCRIPTION	DRAWN	CHECKED	DATE	COMMENTS:
A	SUBMITTALS SENT	ASR		--/--/--	HAT CHANNEL AND SOUND DEADENER TO BE APPLIED IN FINAL ASSEMBLY
					QTY: N/A



**INTER DYNE
SYSTEMS, INC**

676 E. Ellis Rd., Norton Shores, MI 49441
Phone: 231-799-8760 Fax: 231-799-9690

PART NO.

84 X 30 X 1 - CTOP - FRAME

MATERIAL: **16GA**

FINISH: **304 #4**