

"SCUL-1B-RFD" 1 BOWL SCULLERY RFD STYLE

Stainless steel scullery with 1 integral sink bowl, *optional Fixed or Removable Lower Shelf, and reinforced RFD style

Features

- 14GA Construction
- 2" x 2" Square Tubing Legs
- 1.5" x 1.5" Square Tubing Stretchers
- 4" x 2" Stainless tube in front
- 8" Front Apron
- 4" Side Aprons
- 2" Square tubing for rear leg attachment
- Adjustable Height Bullet Feet
- *Please see SCUL- or -DLX drawings for additional options

FAUCET STRETCHER BEHIND

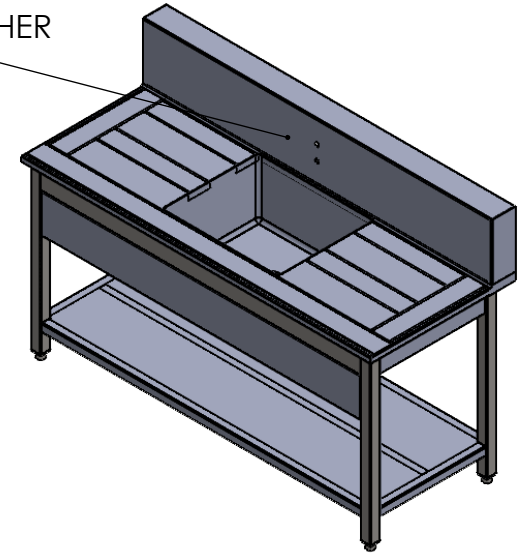
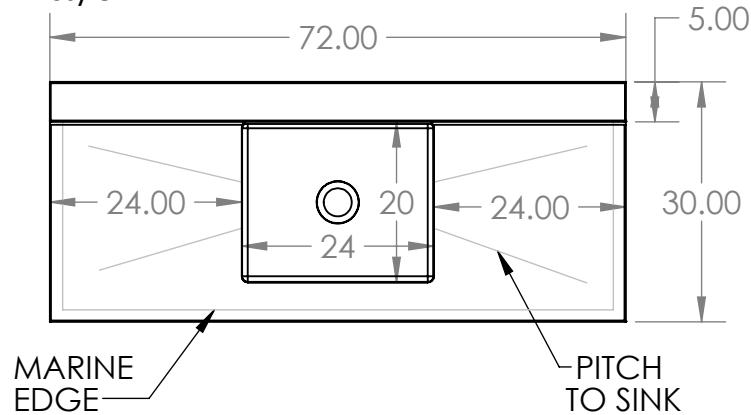

4" X 2" STAINLESS TUBE

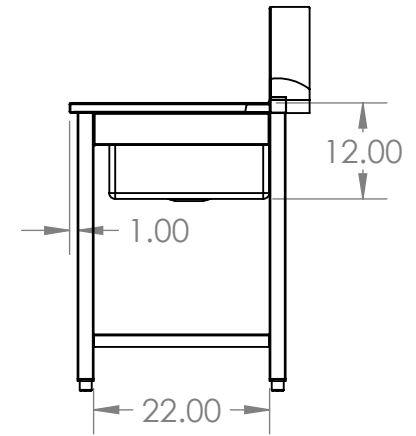
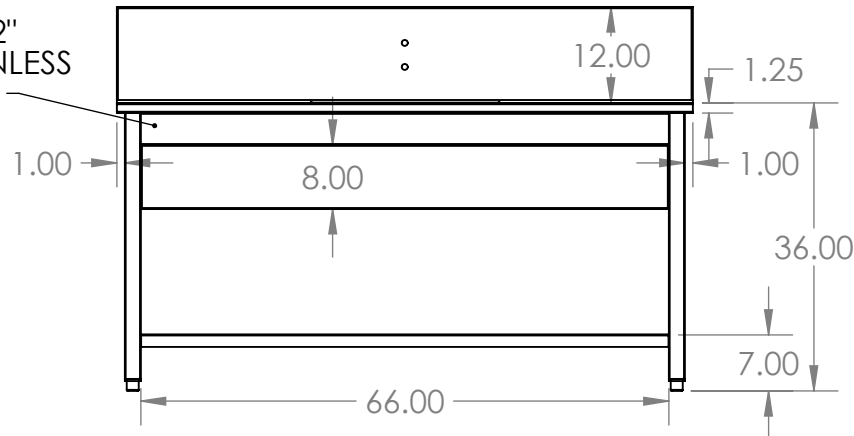

UNLESS OTHERWISE SPECIFIED:

DIMENSIONS ARE IN INCHES
TOLERANCES:
ANGULAR ±2.50°
ONE-PLACE ±0.5
TWO-PLACE ±0.13

PROPRIETARY AND CONFIDENTIAL

THE INFORMATION CONTAINED IN THIS DRAWING IS THE SOLE PROPERTY OF INTER DYNE SYSTEMS. ANY REPRODUCTION IN PART OR AS A WHOLE WITHOUT THE WRITTEN PERMISSION OF INTER DYNE SYSTEMS IS PROHIBITED.

REV.	REVISION DESCRIPTION	DRAWN	CHECKED	DATE	COMMENTS:
A	SUBMITTALS SENT	ASR		05/20/22	HAT CHANNEL AND SOUND DEADENER TO BE APPLIED IN FINAL ASSEMBLY
					QTY:



INTER DYNE SYSTEMS, INC

676 E. Ellis Rd., Norton Shores, MI 49441
Phone: 231-799-8760 Fax: 231-799-9690

PART NO.

SCUL-72-1B-RFD

MATERIAL: **14GA**

FINISH: **304 #4**