

PRODUCT DIMENSIONS

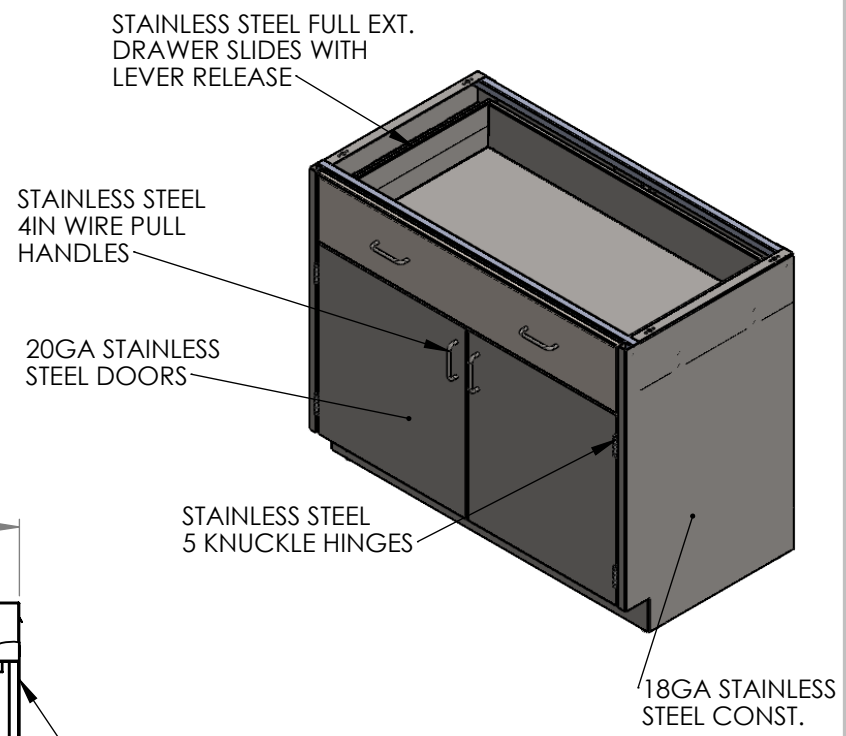
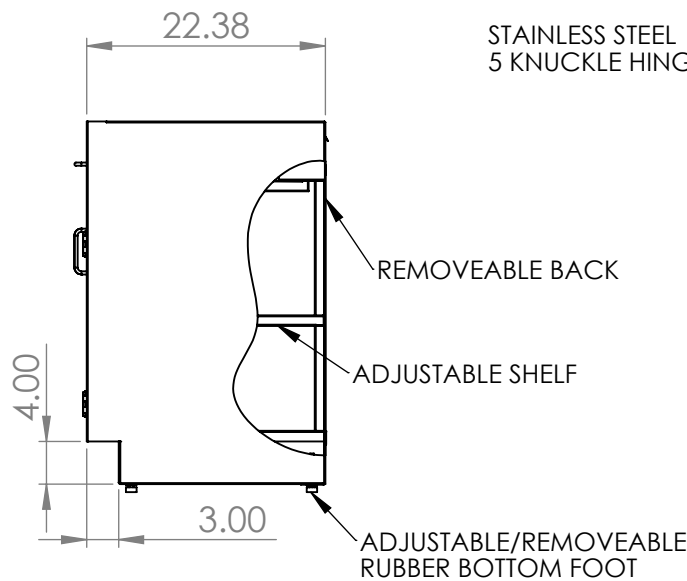
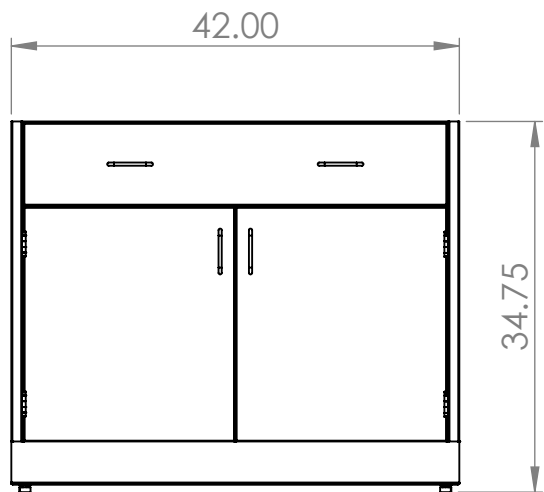

UNLESS OTHERWISE SPECIFIED:
 DIMENSIONS ARE IN INCHES
 TOLERANCES:
 ANGULAR ±2.50°
 ONE-PLACE ±0.5
 TWO-PLACE ±0.13

PROPRIETARY AND CONFIDENTIAL
 THE INFORMATION CONTAINED IN THIS DRAWING IS THE SOLE PROPERTY OF INTER DYNE SYSTEMS. ANY REPRODUCTION IN PART OR AS A WHOLE WITHOUT THE WRITTEN PERMISSION OF INTER DYNE SYSTEMS IS PROHIBITED.

REV.	REVISION DESCRIPTION	DRAWN	CHECKED	DATE	COMMENTS:
A	SUBMITTALS SENT	ASR		--/--/--	

QTY: N/A



INTER DYNE SYSTEMS, INC
 676 E. Ellis Rd., Norton Shores, MI 49441
 Phone: 231-799-8760 Fax: 231-799-9690

PART NO.
SBC3542-B
 MATERIAL: **18GA** FINISH: **304 #4**